

**eWON 2101CD™**

**VPN Router  
Remote Access Server (RAS)  
Programmable Industrial Router (PIR)**

# Installation Guide

**Rev. 1.6**



**Cool  
Internet  
Telecontrol  
Solutions**

 **eWON**  
ACT'L group

---

1	Product description .....	4
1.1	Introduction.....	4
1.2	General specification of the hardware platform .....	4
1.3	Functions of the eWON2101CD™ .....	4
1.3.1	General .....	4
1.3.2	Virtual Private Network.....	4
1.3.3	Remote Access Server functions .....	4
1.3.4	Ethernet to Serial Gateways .....	5
1.3.5	Programmable Industrial Router functions.....	5
1.4	Typical applications.....	5
1.5	Part Numbers and internal options .....	6
2	eWON technical documentation.....	7
3	Housing and markings .....	8
3.1	Housing Interfaces.....	8
3.2	Markings .....	9
3.3	Safety, Environmental & Regulatory Information.....	10
3.3.1	Scope.....	10
3.3.2	Applicable European Directives .....	10
3.3.3	Applicable Safety Standards .....	10
3.3.4	FCC Compliance.....	10
3.3.5	Certifications.....	11
3.4	Equipment information and versions .....	12
3.5	Mechanical outline .....	13
3.6	Mounting and environmental conditions .....	14
3.7	Preparing the installation .....	14
3.8	Specification for external power supply selection.....	14
3.8.1	Auto fuse.....	15
4	Front panel control LEDs .....	15
5	Specifications of communication interfaces and I/Os.....	16
5.1	Ethernet Port .....	16
5.2	Embedded PSTN 56k Modem (optional) .....	16
5.3	Embedded ISDN Modem (optional) .....	16
5.4	Embedded GPRS-EDGE quad band Modem (optional) .....	17
5.4.1	SIM-card installation .....	17
5.5	Embedded UMTS Modem (optional).....	18
5.5.1	SIM-card installation .....	18
5.6	Embedded HSUPA modem (optional) .....	19
5.6.1	SIM-card installation (HSUPA modem) .....	19
5.7	Configurable serial port .....	20
5.8	MPI port .....	21
5.9	Digital input.....	21
5.10	Digital output.....	22
6	IP parameters configuration .....	23
6.1	Resets .....	24
6.1.1	User Reset.....	24
6.1.2	Factory Reset.....	24
7	Technical support .....	25
8	Appendix: Pinouts and connections .....	25
8.1	Power Supply.....	25
8.2	Ethernet.....	26
8.2.1	Ethernet LAN.....	26
8.2.2	Direct connection .....	27
8.2.3	Connection over hub/router.....	28
8.3	RJ45 connector .....	29
8.4	Input/Outputs.....	30



---

8.5 Serial Port .....	31
8.6 MPI port.....	32
8.7 PSTN / ISDN phone line connector .....	33
8.8 Antenna .....	33
8.8.1 Connector specifications .....	33
8.8.2 Antenna specifications .....	34

## 1 Product description

---

### 1.1 Introduction

The eWON2101CD™ is the **Compact Design** evolution of the eWON2101™.

The eWON2101CD™ is the *entry level industrial-grade Router* for System Integrators in utilities/infrastructure projects and machine Builders/OEMs. See our web site <http://www.ewon.biz> to get further information about the eWON range. The eWON is a terminal that enables access to technical data, whatever their format is. It is configurable by web pages. It is secure because it meets the toughest industrial standards and has restricted access features (required in open networks).

The eWON2101CD™ embeds a modem (PSTN, ISDN, GPRS, UMTS or HSUPA).

The eWON range supports the TCP/IP and PPP protocols. This brings you all the benefits of an universally recognized standard network. It also allows you to use popular software tools like Internet Explorer, FTP client, SNMP Manager, Mail Recipient ... and so to reduce significantly your costs (implementation and ownership).

### 1.2 General specification of the hardware platform

- Processor ARM clocked @ 75Mhz, 16Mb SDRAM, 32Mb Flash
- Backed up real time clock (RTC) with 24 Hours autonomy
- Battery with 10 years autonomy (for RTC)
- External power supply 12-24 VDC +/- 20%, consumption: 10W max
- 1 Ethernet port 10/100Mb BaseTx
- 1 Serial port configurable in RS232/RS422/RS485  
OR  
1 MPI port (up to 12 Mbits/sec)
- 1 digital input (DI)
- 1 digital output (DO)
- DIN rail mounting compliant with EN50022 (latch)
- Environmental conditions (operating):  
Ambient T°: from -20°C to +70°C for eWON with GPRS, UMTS or HSUPA modem  
Ambient T°: from 0°C to +50°C for eWON with PSTN or ISDN modem  
Humidity: from 0 to 80% non condensing

### 1.3 Functions of the eWON2101CD™

#### 1.3.1 General

- Ethernet Gateway to serial protocols
- Web server – fully customizable web pages
- Programmable by BASIC scripts or JAVA
- Alarm management
- Report generation

#### 1.3.2 Virtual Private Network

- Allow to build your own Virtual Private Network (VPN) thanks to OpenVPN technology

#### 1.3.3 Remote Access Server functions

- Remote Access Server (RAS) and TCP/IP Server
- PAP/CHAP Authentication
- Login/password
- Remote network access
- User access control
- Security: NAT, IP filtering
- Conventional and internet callback

### **1.3.4 Ethernet to Serial Gateways**

- MODBUS TCP to MODBUS RTU
- XIP to UNITELWAY
- EtherNet/IP™ to DF1
- FINS TCP to FINS Hostlink
- ISOTCP to PPI (optionnaly MPI)
- VCOM / ASCII

### **1.3.5 Programmable Industrial Router functions**

- Automatic routing of protocols
- Programmable routing from I/O and Tag names (BASIC)

## **1.4 Typical applications**

- Alarm management
- Sending alarms by network, phone, Email and/or SMS
- Remote measurements, loop back, control and monitoring
- Predictive and operational maintenance
- Diagnosis and machinery status control
- Process and machinery activity logs
- Commissioning support
- Remote programming
- Interface for Application Service Providers (ASP)

## 1.5 Part Numbers and internal options

Part Number structure of the eWON product range:

### EWaabzm

Where:

**aa = Type of hardware platform**

- 33 = eWON2101CD™

**b = Power supply**

- 2 = Low voltage 12-24DC power supply

**z = Serial Port type**

- 0 = RS232 / RS422 / RS485 serial port
- 6 = MPI port

**m= Modem**

- 3 = ISDN EU modem
- 4 = PSTN 56k modem
- 8 = GPRS quad band
- A = HSUPA modem
- B = UMTS Global

Examples of Part Numbers for the eWON2101CD™ platform:

Type/Description	Part Number
eWON2101CD™/ISDN (ISDN modem)	EW33203
eWON2101CD™/PSTN 56 (PSTN 56 modem)	EW33204
eWON2101CD™/GSM/GPRS (GSM/GPRS modem)	EW33208
eWON2101CD™/HSUPA (HSUPA modem)	EW3320A
eWON2101CD™/UMTS (UMTS Global modem)	EW3320B
eWON2101CD™-MPI/PSTN 56 (PSTN 56 modem)	EW33264

Table 1: Examples of Part Numbers

## 2 eWON technical documentation

The eWON technical documentation is structured in 4 different levels as shown in the table below:

Level	Title	Contents
1	Hardware  <b>Installation Guide</b> <i>(the present document)</i>	Detailed description of the hardware platform, of its interfaces, available options. Hardware specifications, conformity to standards. Installation recommendations and pinout of the connectors. Exists for each eWON type.
2	Software  <b>Reference Guides</b>	Exhaustive reference guides to use all advanced functions of the eWON. <ul style="list-style-type: none"> <li>• General Reference Guide (RG-001)</li> <li>• Programming Guide (RG-002)</li> <li>• Web reference guide (RG-003)</li> </ul>
3	<b>Application User Guides</b>	Guides covering one application topic. For examples: <ul style="list-style-type: none"> <li>• eWON Getting Started</li> <li>• eWON MPI-Teleservice</li> <li>• Unitelway topology Gateway XIP</li> <li>• ...</li> </ul>
4	<b>Knowledge Base</b>	Small document about one technical topic. For examples: <ul style="list-style-type: none"> <li>• How to do a PING function with Basic</li> <li>• eWON serial number structure</li> <li>• eWON modem type</li> <li>• ...</li> </ul>

Table 2: eWON technical documentation different levels

All those manuals are available for download in pdf format on the eWON website: <http://support.ewon.biz>.

## 3 Housing and markings

### 3.1 Housing Interfaces

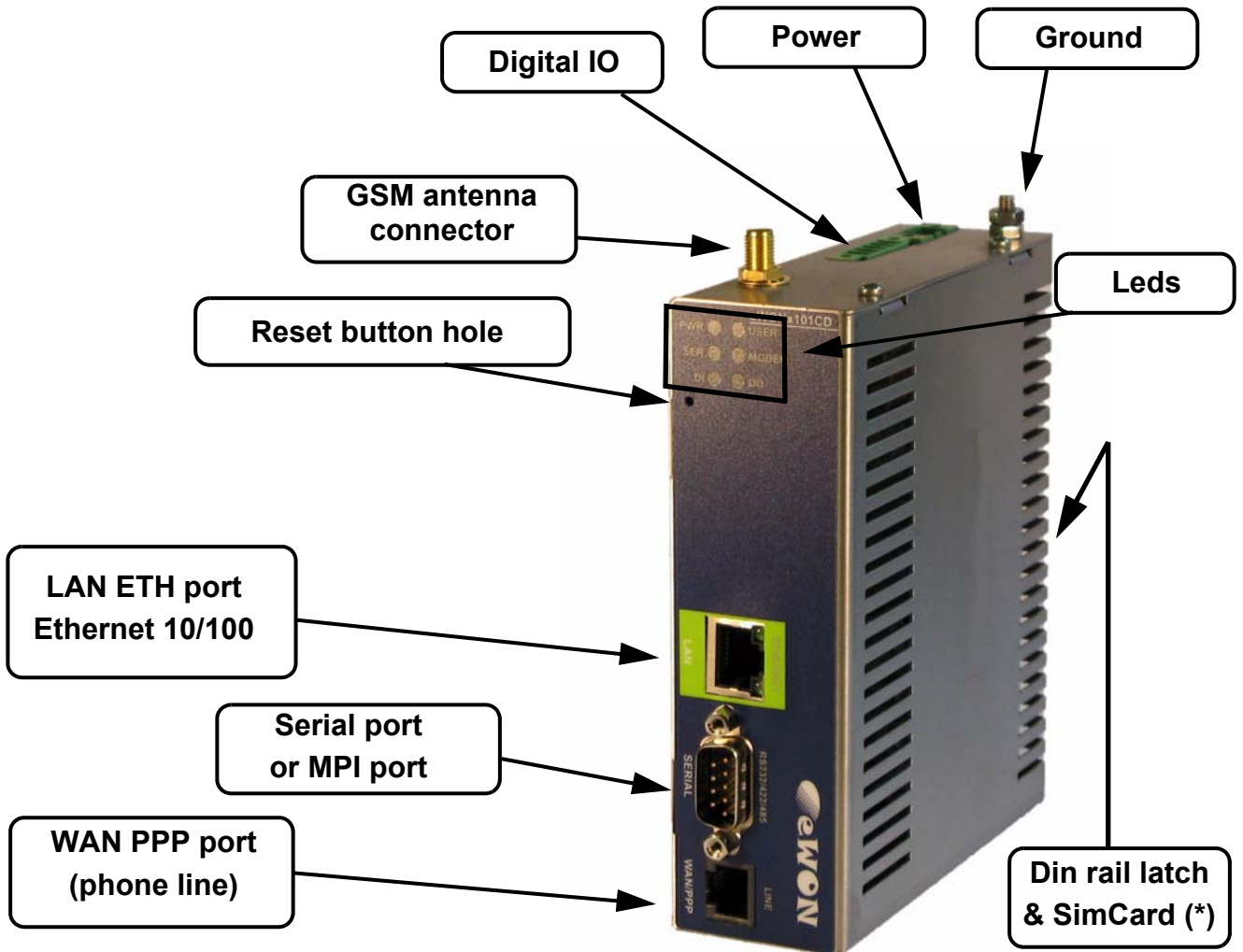

Figure 1: Housing



(\*) For HSUPA modem, the SIM card drawer is located on eWON top side.  
See “Embedded HSUPA modem (optional)” on page 19.

### 3.2 Markings

The identification label of the eWON is placed at the left hand side of the housing. The label is composed of the following fields:

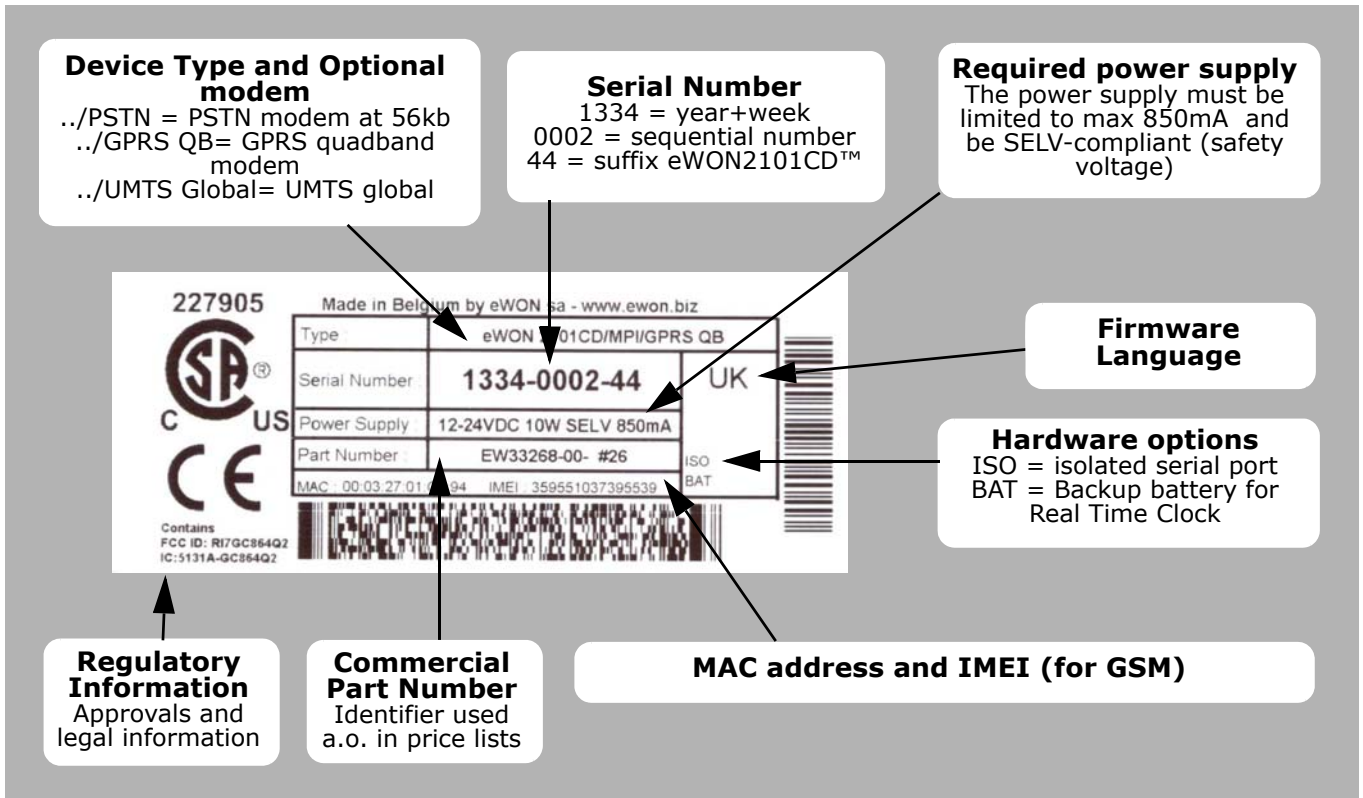

Figure 2: eWON Label

The eWON Serial Number (SN) is an important traceability tool both for the user and for the manufacturer. Therefore, next to the product label, each eWON has its serial number stored in the flash memory. This SN is also used in order to scan the network for eWONs and to assign its IP address, subnet mask and gateway. For more details, [See “Equipment information and versions” on page 12.](#)

## 3.3 Safety, Environmental & Regulatory Information

### 3.3.1 Scope

The present heading addresses Safety, Environmental & Regulatory Information for the eWON2101CD.

The eWON2101CD range including its optional modems belongs to class A Information Technology Equipment (ITE). In a domestic environment this product may cause radio interference in which case the user may be required to take appropriate measures.

### 3.3.2 Applicable European Directives

The eWON2101CD range is in conformity with the following directives:

- EMC Directive 2004/108/EC
- RoHS Directive 2002/95/EsC

When applicable\*, the product conform to the corresponding articles:

- R&TTE Directive 1999/5/EC
- FCC 41 CFR

\* Applies to eWONs with embedded wireless modem.

### 3.3.3 Applicable Safety Standards

The eWON2101CD range including optional modems is in conformity with the following safety standards:

- IEC/EN 60950-1
- UL 60950-1
- CSA-C22.2 No 60950-1-07

#### **Battery:**

Caution risk of explosion if battery is replaced by an incorrect type. Dispose of used battery according to the instructions. Do not disassemble, crush or puncture battery. Do not attempt to open or service battery. Do not dispose of batteries in a fire or with household waste.

### 3.3.4 FCC Compliance

The eWON2101CD range including optional modems complies with Part 15 of the FCC Rules. Operating is subject to the following two conditions:

1. This device may not cause harmful interference, and
2. This device must accept any interference received, including interference that may cause undesired operation.

The telecommunication modules used into the eWON routers meets regulatory requirements. They have been granted modular approval for mobile applications. Integrators may use eWON with telecommunication modules in their host application that can be categorized as mobile devices without additional FCC or R&TTE certification approvals if the following conditions are met (otherwise, additional FCC approvals must be obtained):

- At least 20 cm (7.88") separation distance between the antenna and the user's body must be maintained at all times.
- The eWON and its antenna must not be collocated or operating in conjunction with any other transmitter or antenna.
- To comply with regulations limiting both maximum RF output power and human exposure to RF radiation, the maximum antenna gain, including cable loss, are given in the § 8.8.2 Antenna Specification
- No modifications can be made by the user that can be of influence on the EMC behaviour of the device.

The FCC defines a *mobile* device as being designed for use “in other than fixed locations and to generally be used in such a way that a separation distance of at least 20 centimeters is normally maintained between radiating structures and the body of the user or nearby persons.”

### **3.3.5 Certifications**

Please check our <http://wiki.ewon.biz/Support/> page to get the current versions of:

- Declaration of Conformity (DoC)
- Other official documents including certificate

## 3.4 Equipment information and versions

The eWON hardware and software revisions can be checked with a web browser on the eWON server. Once logged onto the eWON, clicking on the eWON logo shows these revisions.

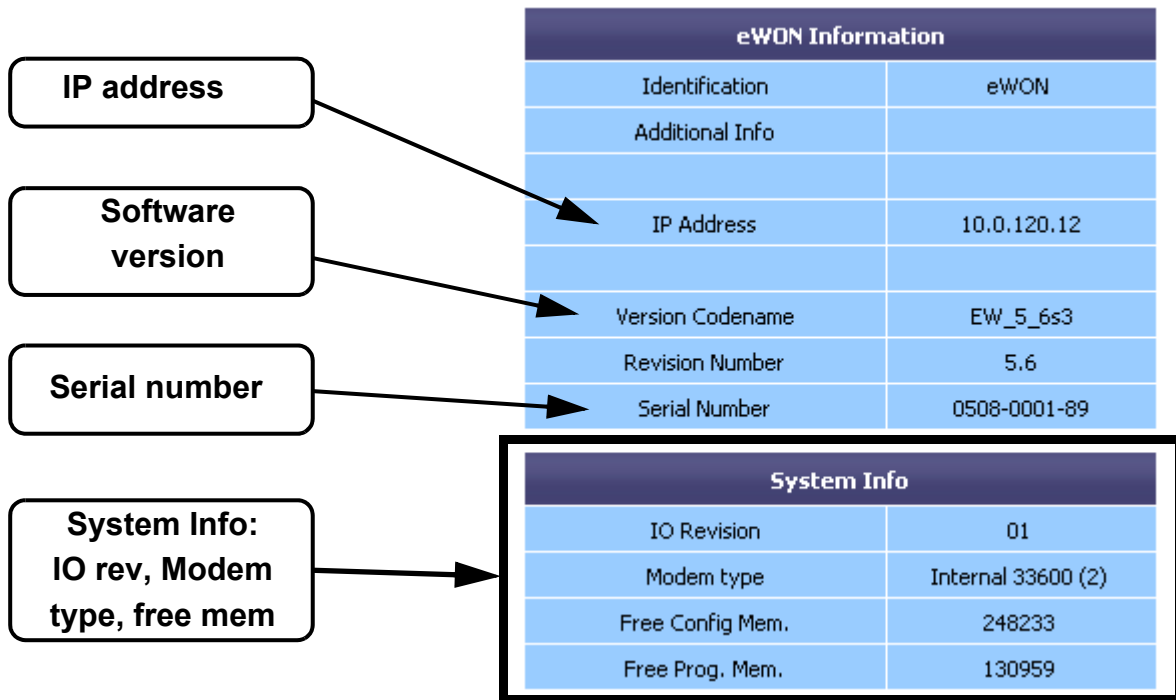

Figure 3: eWON info page details

## 3.5 Mechanical outline

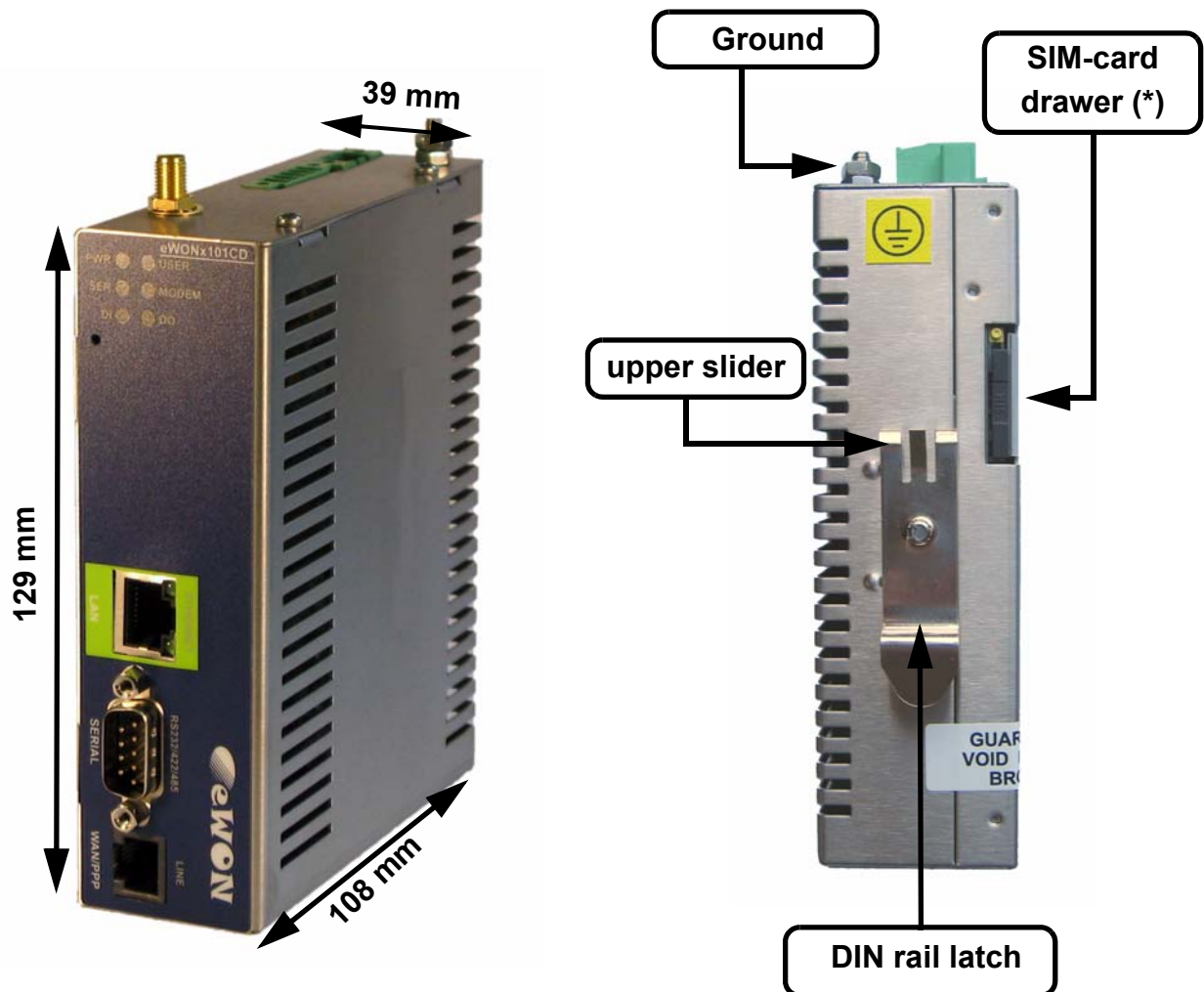

Figure 4: Left: Mechanical Outline - Right: DIN-rail latch

The eWON must be fastened on a 35mm DIN rail compliant with EN50022.

To put the unit in place, insert the upper slider into the upper part of the rail, with the eWON™ tilted around 20°. Then push and rotate the eWON™ downward to put the unit right.

The eWON2101CD™ is now safely fastened.

(\*) For HSUPA modem, the SIM card drawer is located on eWON top side. See "Embedded HSUPA modem (optional)" on page 19.

### 3.6 Mounting and environmental conditions

The eWON unit has an IP31 protection grade. It is therefore not suited for outdoor mounting. The design of the unit is such that it has to be integrated in an enclosed electrical cabinet, protected from excessive heat, humidity and dust. The eWON2101CD™ is complying to the CE-marking requirements regarding electromagnetic compatibility (EMC) within an industrial environment.

The normal mounting position is wall mounted on DIN-rail (EN 50022). The unit is suited to work in any other position.

The equipment will operate within specified tolerances only if the following environmental conditions are respected:

<b>Ambient temperature range</b>	-20°C to +70°C for eWON with GPRS QB or UMTS Global modem
	0°C to +50°C for eWON with PSTN or ISDN modem
<b>Ambient humidity</b>	0-80% non-condensing

### 3.7 Preparing the installation

The recommended free space in the cabinet for the eWON should be at least: 80-mm wide x 200-mm high x 160-mm deep (terminal block excluded). A piece of rigid DIN-rail profile (flat 35mm wide) of suitable length should be firmly fastened, horizontally, in the middle of the area.

Grounding the eWON is necessary to eliminate unwanted transients (lightning protection) and to conform to the EMC requirements. Therefore, a ground screw is available at the top of the unit. Connect this screw directly to a low impedance ground.

### 3.8 Specification for external power supply selection

The eWON2101CD™ has to be supplied by an external voltage source ranging from 12 to 24 VDC. The power supplied must be a Class 2 or Level 3, SELV-compliant (Safety Extra Low Voltage) and limited in current to a max of 850mA. The safety voltage power supply is not part of the delivery. .

Specification	Value
<b>Secondary PS voltage</b>	from 12 to 24 VDC +/-20% (SELV-compliant)
<b>Max secondary PS current</b>	850 mA max.
<b>eWON current protection</b>	2A by auto fuse
<b>eWON voltage protection</b>	30V by transil
<b>eWON EMI filter</b>	Common mode filter (*)
<b>Power absorbed</b>	10 Watts
<b>Input Protection</b>	Protected against polarity inversion

Table 3: Specification for external power supply selection

(\*) Properly ground the unit with the earth screw at the top of the unit. This is mandatory to ensure the security and the electro mechanical compatibility (EMC) of the device.

Equipment Supplied by Class 2 or Level 3 Power Supply.

### 3.8.1 Auto fuse

An auto fuse placed just after the power input protects the eWON devices against short circuits. This component returns by itself to its normal state when the short circuit has disappeared and after the component has been cooling down. Would this fuse happen to operate, please check the device for presence of loose metal parts inside likely to generate a short circuit. If the problem recurs even after such a verification, then return the device to the vendor for further investigation.

## 4 Front panel control LEDs

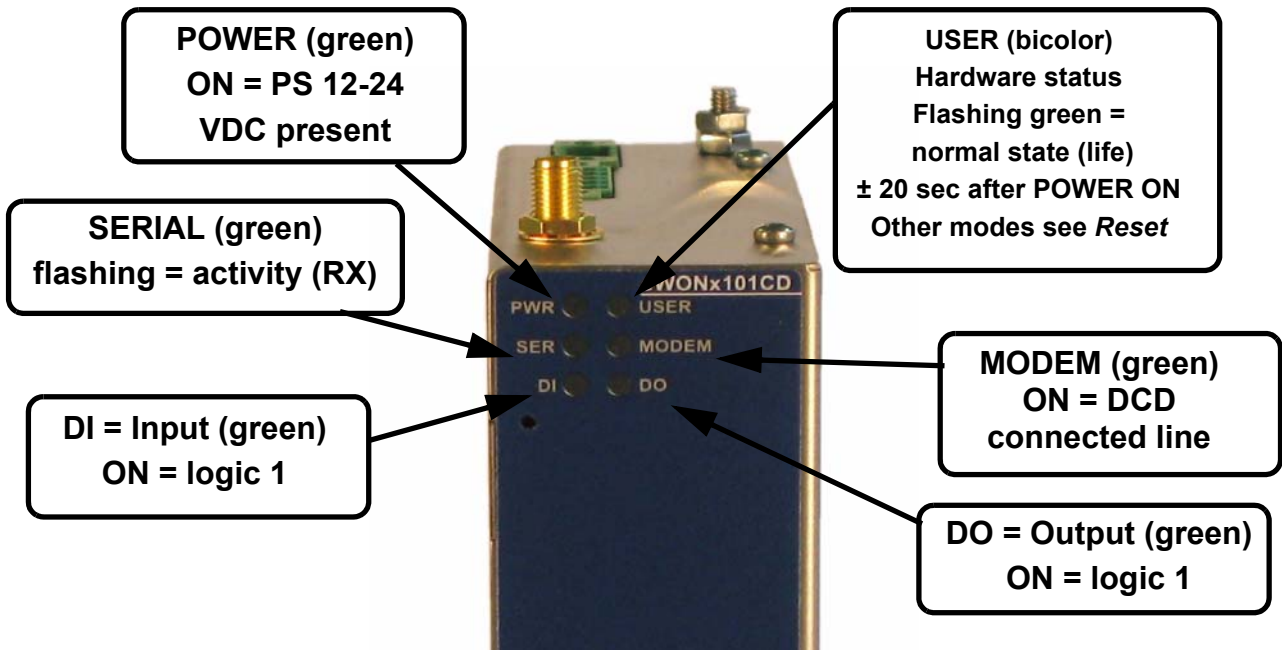

Figure 5: Front Panel leds description

## 5 Specifications of communication interfaces and I/Os

### 5.1 Ethernet Port

The eWON2101CD™ has one ethernet interface:

- a LAN (Local Area Network) with one port

Specification	Value
Applicable standard	10/100BaseTX
Isolation	1,5 kV
Pinout RJ45 connector	See label and appendix ( <i>RJ45 connector on page 29</i> )

Table 4: Ethernet port specification

Please refer to the appendix (Direct connection on page 27 and Connection over hub/router on page 28) for information on the different Ethernet connection modes (straight and crossed cables).

### 5.2 Embedded PSTN 56k Modem (optional)

Specification	PSTN
Max baud rate	(V92) 56 kbps
Pinout phone line connector	See label and appendix (PSTN / ISDN phone line connector on page 33)
Leased Line mode	No

Table 5: PSTN modem specification

### 5.3 Embedded ISDN Modem (optional)

Specification	ISDN
ISDN specification	ISDN BRI S0.1.430
Type	1B+D
Max baud rate	64 Kb
Certification	---

Table 6: ISDN modem specification



## 5.4 Embedded GPRS-EDGE quad band Modem (optional)

Specification	GPRS-EDGE
<b>Bands</b>	Quad band EGSM 850/900/1800/1900 MHz
<b>E-GPRS Class</b>	Class 10
<b>Max baud rate</b>	<b>115 kbps</b>
<b>Compliant to standards</b>	R&TTE, CE, FCC
<b>Certificate number</b>	---
<b>Antenna connector (*)</b>	Type SMA-F

Table 7: GPRS QB modem specification

(\*) Tightening torque for SMA antenna connector: MAX 0.5N.m (manual tightening should be used as a reference). See "Antenna" on page 33.

### 5.4.1 SIM-card installation

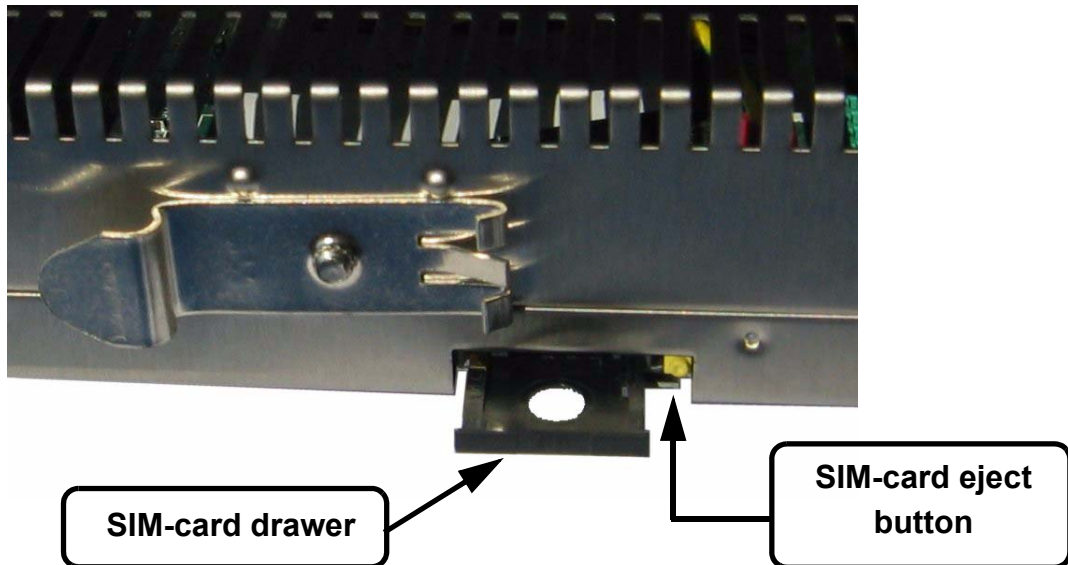

Figure 6: SIM-card insertion

## 5.5 Embedded UMTS Modem (optional)

Specification	UMTS Global
<b>Bands</b>	Quad band EGSM (850/900/1800/1900 MHz) Tri band UMTS/HSDPA (850/1900/2100 MHz)
<b>Class</b>	GPRS Multi-slot Class 12 EDGE Multi-slot class 12
<b>Max baud rate</b>	<b>230 kbps</b>
<b>Compliant to standards</b>	R&TTE, CE, FCC
<b>Certificate number</b>	---
<b>Antenna connector (*)</b>	Type SMA-F

Table 8: UMTS Global modem specification

(\*) Tightening torque for SMA antenna connector: MAX 0.5N.m (manual tightening should be used as a reference). See "Antenna" on page 33.

### 5.5.1 SIM-card installation

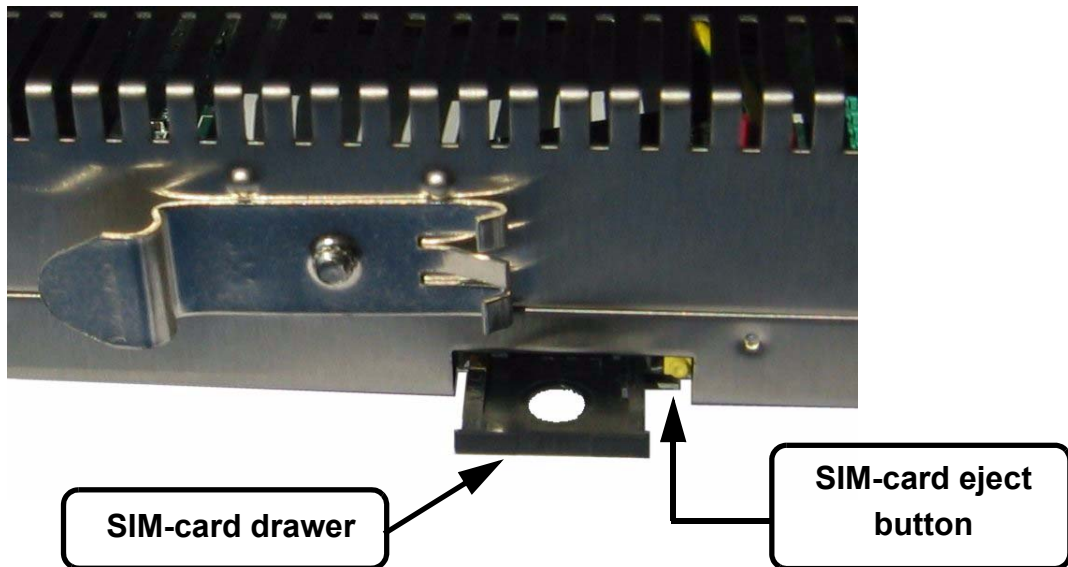

Figure 7: SIM-card insertion

## 5.6 Embedded HSUPA modem (optional)

Specification	HSUPA
<b>Bands</b>	Quad band EGSM (850/900/1800/1900 MHz) Tri band UMTS/HSUPA (850/1900/2100 MHz)
<b>Class</b>	GPRS Multi-slot Class 12 EDGE Multi-slot class 12
<b>Max baud rate</b>	<b>921 kbps</b>
<b>Compliant to standards</b>	R&TTE, CE, FCC
<b>Certificate number</b>	---
<b>Antenna connector (*)</b>	Type SMA-F

Table 9: HSUPA modem specification

(\*) Tightening torque for SMA antenna connector: MAX 0.5N.m (manual tightening should be used as a reference). See "Antenna" on page 33.

### 5.6.1 SIM-card installation (HSUPA modem)

For HSUPA modem only, the SIM-card drawer is located on the top of the eWON.



## 5.7 Configurable serial port

Specification	Value
Physical modes (configurable)	RS232/RS485/RS422
Isolation	Not isolated
Pinout connector	See label and appendix ( <i>Serial Port on page 31</i> )

Table 10: Serial port specification

The configuration of the physical serial mode is done by a set of 4 dip switches located on left side of the unit.



The settings of the switches are shown in the table below (note: switch 1 is the right one).



Positions	Mode
4 3 2 1 OFF  ON	RS232
4 3 2 1 OFF  ON	RS422, RS485 WITHOUT polarisation and termination resistor
4 3 2 1 OFF  ON	RS422, RS485 WITH polarisation and termination resistor

Table 11: Serial mode configuration switches

**Note:** the switch configurations shown above are the only configurations giving satisfactory results.

**Warning:** The switch 2 is reserved and must stay OFF.

Note that switch 3 & 4 need to have the same position (both ON or both OFF). When they are ON, it connects the internal polarisation (typ 680 Ohms) and termination (typ 120 Ohms) resistors. This configuration applies only to RS485/RS422 lines conforming to good practices.

## 5.8 MPI port

The MPI port is easily identifiable with its light blue square surrounding a female DB9 connector.

Specification	Value
Physical mode	MPI
Speed	<ul style="list-style-type: none"> <li>• 9.6 kBauds</li> <li>• 19.2 kBauds</li> <li>• 45.45 kBauds</li> <li>• 93.75 kBauds</li> <li>• 187.5 kBauds</li> <li>• 1.5 MBauds</li> <li>• 3.0 MBauds</li> <li>• 6.0 MBauds</li> <li>• 12.0 MBauds</li> </ul>
Polarisation	100 kOhms
Termination	None
Pinout connector	See label and appendix (MPI port on page 32)



## 5.9 Digital input

Specification	Value
Input voltage range	0 to 24 VDC
Input voltage absolute max (varistor protection)	33 VDC
Zero state max input voltage (OFF)	5 VDC
One state voltage range (ON)	10 to 30 VDC
One state currents (ON)	3.8mA @ 12VDC 8.2mA @ 24VDC
Isolation	3,5 kV
Pinout connector	See label and appendix (Input/Outputs on page 30)

Table 12: Specification of the digital input

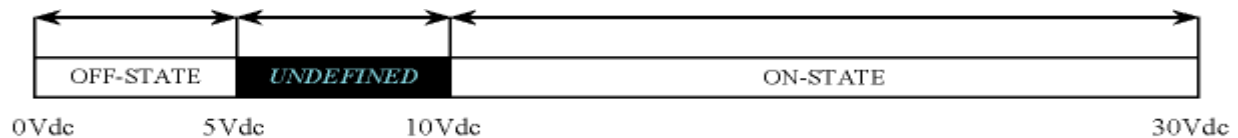

Figure 8: Digital input: state vs voltage

The input range extends from 0 to 24VDC (30VDC max). A zero logic (OFF) state is detected when the input level is below 5Vdc. A one logic (ON) state is detected when the input level is above 10Vdc.

**Warning: the logic level is undefined when the input is ranging between 5 and 10VDC.**

## 5.10 Digital output

Specification	Value
Type of output	Open drain (MOSFET)
Max current (external source)	200mA @ 30 VDC
Isolation	3,5 kV
Pinout connector	See label and appendix ( <i>Input/Outputs on page 30</i> )

Table 13: Specification of the digital output

This digital output is activated by an open drain MOSFET transistor driven by an optocoupler. The maximum current flow into this transistor has a characteristic above the value specified in the eWON, in order to cope with the switching power losses. The transistor used is in an open drain type with pre drive. This means the relay power supply has to be supplied from an external source to the pre drive electronics.

The diagram below shows the external wiring needed for correct operation of the digital output. A relay has been chosen for this sample application but any load within the specifications can be used instead.

**Warning:** note that this is a sink only output to ground (the transistor acts like a switch to ground).

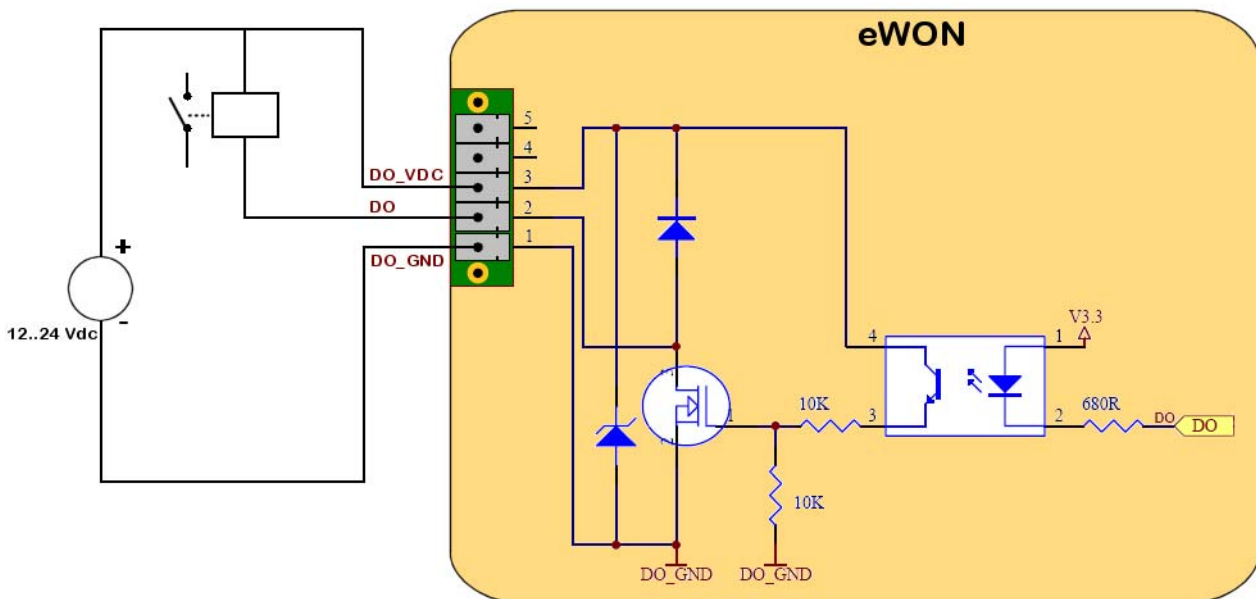

Figure 9: Digital output: wiring diagram

## 6 IP parameters configuration

---

**Warning:** normally you cannot communicate with a device of which you don't know the IP parameters. Therefore, there is a special tool (called "eBuddy") you can download from the eWON Internet site <http://www.ewon.biz>. Start this application once you have connected your eWON to the network. The application will scan the whole network and will identify all eWONs that are connected, including their IP parameters (Address and subnet mask) and their serial number. The utility allows also to edit the IP parameters. IP parameters always have to be defined in full agreement with network policies applicable within your organisation (ask your network administrator).

Default settings:

LAN interface	
IP address	10.0.0.53
Subnet mask	255.255.255.0

Table 14: LAN IP factory config

Modem interface (incoming PPP)	
IP address	202.0.0.240
Subnet mask	255.255.255.0

Table 15: PPP IP factory config

**note:** By default, the incoming PPP connection is allowed.

## 6.1 Resets

**Warning:** you should not reset your eWON unless you have been told to do so by someone of our technical support. The concerned files (differs depending on reset type) are totally lost and unrecoverable after being formatted.

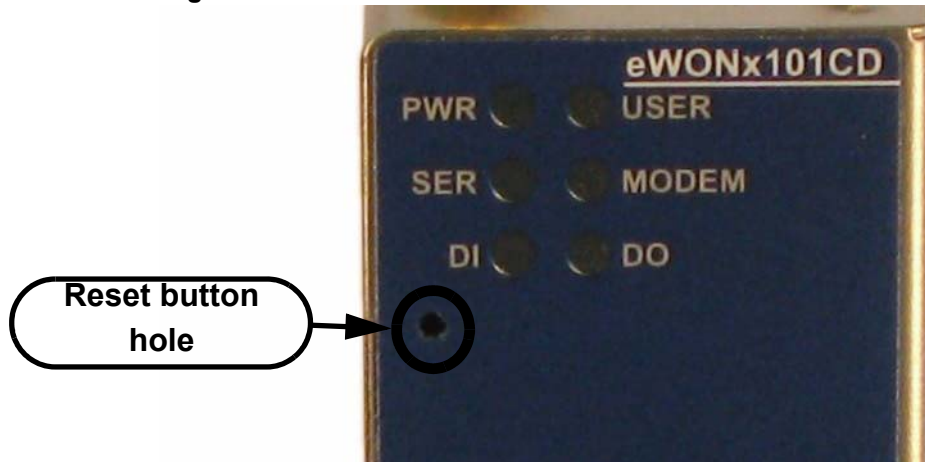

To press the reset button, you will need a propelling pencil or an unfold paper clip to pass through the hole in the front panel.

### 6.1.1 User Reset

This is the first level and most usual level of reset. It consists in formatting only the « user file » part of the non volatile memory. The Tag configuration and the customer web site are part of the formatted files.

You generate this first level reset by pressing and maintaining the reset button during approximately 4 seconds after powering the eWON up until the “USER” LED flashes in red 1x per second. When this state is reached, release the button and wait approximately 30 secs until the procedure is completed. The eWON restarts automatically and is ready to communicate. This type of reset does not modify the communication parameters.

### 6.1.2 Factory Reset

This second level reset is used only exceptionally because it formats all non volatile memories and make the eWON returning to its factory defaults. This operation consists in 3 stages:

- Formatting of all non volatile memories, including all COM parameters and IP addresses
- Return to ex-factory configuration (default config)
- Full hardware auto test with result shown by the “USER” LED

You generate this second level reset by pressing and maintaining the reset button during approximately 20 secs after powering up the eWON until the “USER” LED remains RED continuously. When this state is reached, release the button and wait approximately during 90 seconds until the procedure is completed. The procedure finishes with the result of the autotest on the “USER” LED. If the autotest is completed successfully, then the “USER” LED will blink in RED with a pattern of 200ms ON and 1,5 sec OFF.

Any other pattern will start with 200ms ON (opening of the pattern) followed by OFF and a certain number of times 1 sec ON that allows to identify the nature of the detected problem. Please call the technical support if you are confronted with an error pattern on the “USER” LED.

**Warning:** you absolutely have to wait until the full autotest procedure is completed without interrupting it. If the autotest is interrupted, the flash memory of the eWON will contain random data likely to make it unstable. In such a case you have to redo the full reset procedure from scratch and wait until it is totally completed.

When performing a full reset, the eWON does NOT restart in normal mode by itself and remains running in diagnose mode. Power the eWON OFF and ON again to restart in normal mode. As described before, the eWON returns to its default COM parameters and IP addresses after this level 2 reset is performed.



## 7 Technical support

If you need technical support, simply fill out the form on the Web site <http://www.ewon.biz>  
 You will also find usefull documentation at <http://support.ewon.biz>

## 8 Appendix: Pinouts and connections

### 8.1 Power Supply

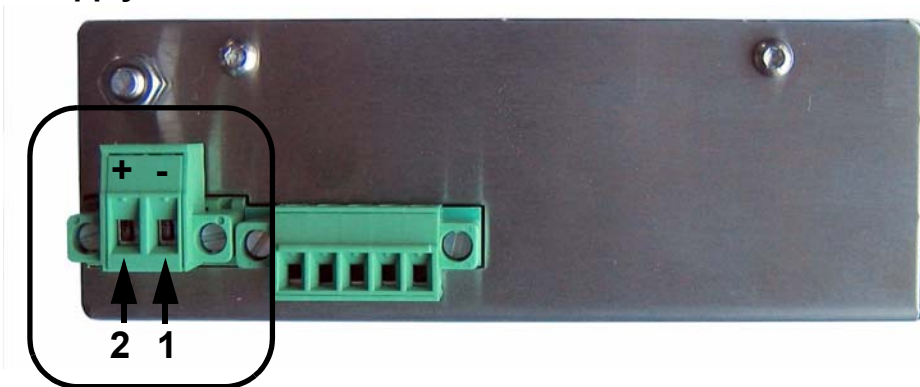

Figure 10: Power supply connector: eWON Mating female connector (included)

- **Manufacturer:**  
 Phoenix Contact GmbH, <http://www.phoenixcontact.com>  
 Part Number: GMSTB 2,5/2-STF-5.08
- **Pinout (see label)**

Pin	Description
1	Ground
2	Positive (+)

Table 16: Pinout Power Supply Connector

## 8.2 Ethernet

By default, only the LAN Ethernet interface of the eWON2101CD™ can be used to access the internal WebSite.

### 8.2.1 Ethernet LAN

The eWON can be accessed by a 10/100BaseTX Ethernet connection. This connection can be made with two different cables (straight or crossed). These cables have 8 copper conductors and are known as UTP Class 5 with RJ45 terminations at both ends.

The type of cable (straight or crossed) depends on the equipment the eWON will be connected to. The most current cases are the direct connection with a PC (crossed) and the connection through a hub/router (straight).

The WAN port have 2 leds showing the state and activity on the port.

	color & activity	Meaning
<b>Upper Led</b>	off	No Link
	green fixed	Link
<b>Lower Led</b>	green blink	Activity (RX or TX)

Table 17: Led meanings on Ethernet WAN



## 8.2.2 Direct connection

If the eWON is connected directly to a PC, then use the crossed cable:

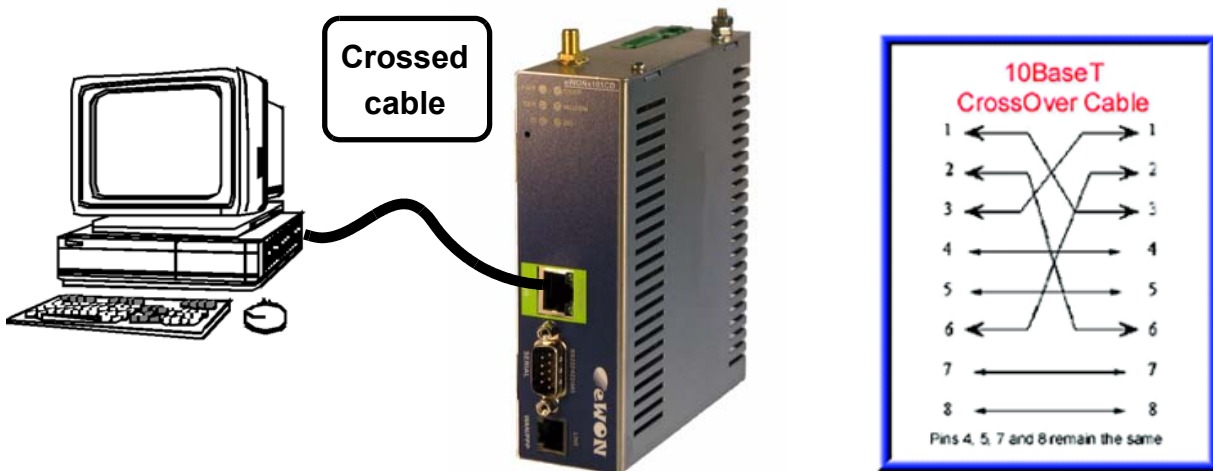

As the LAN interface is “autosense”, you can use a crossed or straight ethernet cable, but generally, a direct connection is done with a crossed cable.

The WAN interface is not “autosense”, then you must use a crossed ethernet cable to make a direct WAN connection.

When cabling over long distance, you have to take care of the twisted pairs. This means that along with the above cabling conventions, the emission (TX+/TX-) and reception (RX+/RX-) signals have to be connected on the same twisted pair:

<b>TX+: pin3, TX-: pin6</b>	Twisted pair 1
<b>RX+: pin1, RX-: pin2</b>	Twisted pair 2

Pins 4, 5, 7 and 8 do not have to be connected. The following picture shows the twisted pair connections:

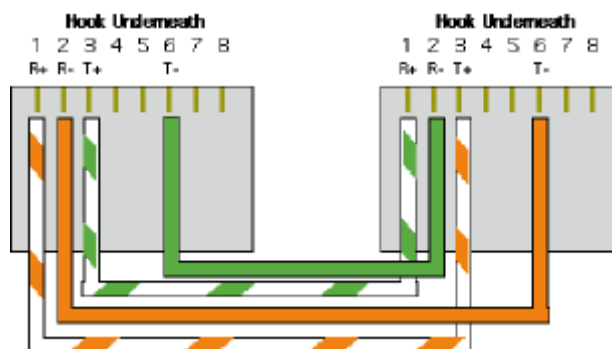

### 8.2.3 Connection over hub/router

If the eWON is connected to a hub, it has to be connected like any other device, with a straight cable. Again, the wiring is as shown on the following picture, and care should be taken to keep the RX and TX signals on twisted pairs:

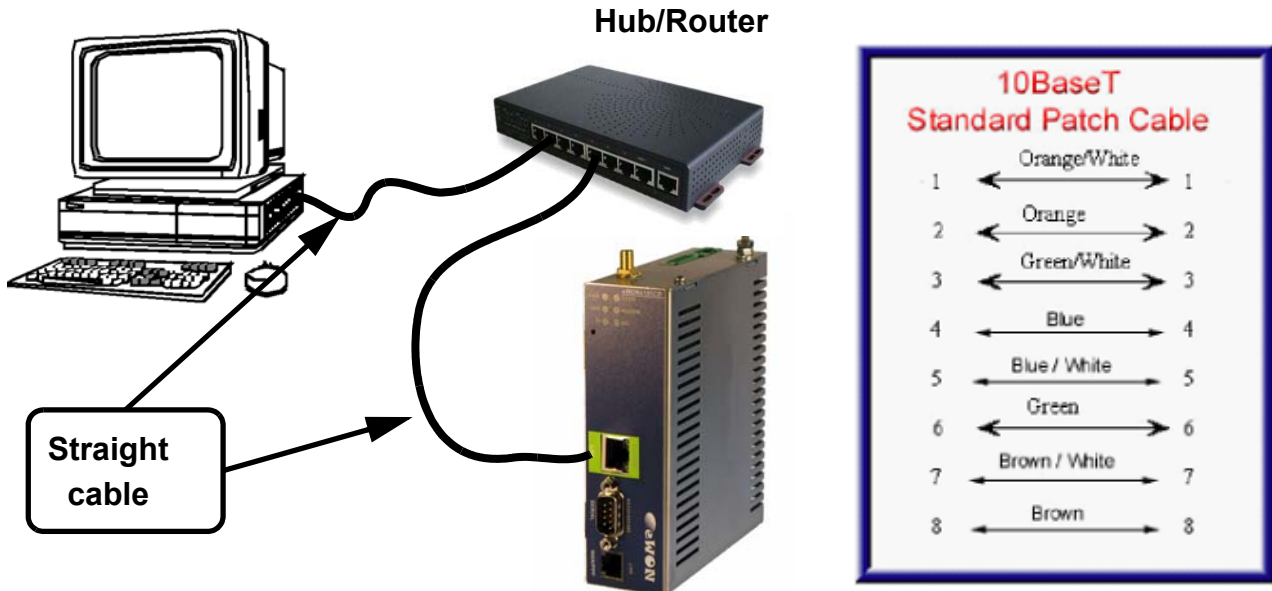

## 8.3 RJ45 connector

The RJ45 connector has got the following pins numbering, as it can be seen on the following picture, showing it from different angles:

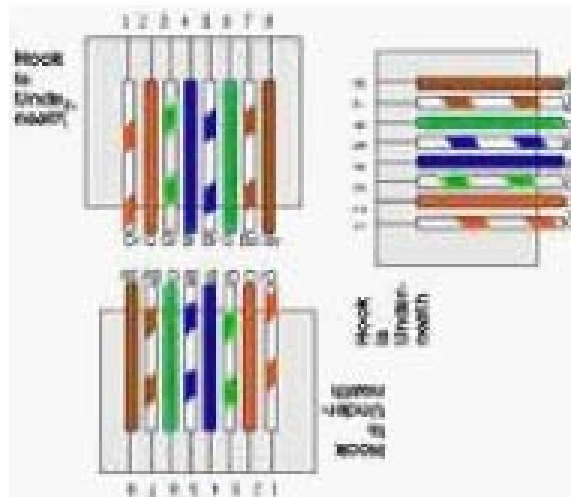
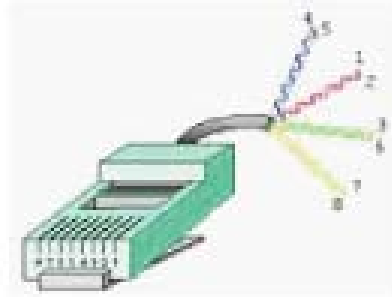

## 8.4 Input/Outputs

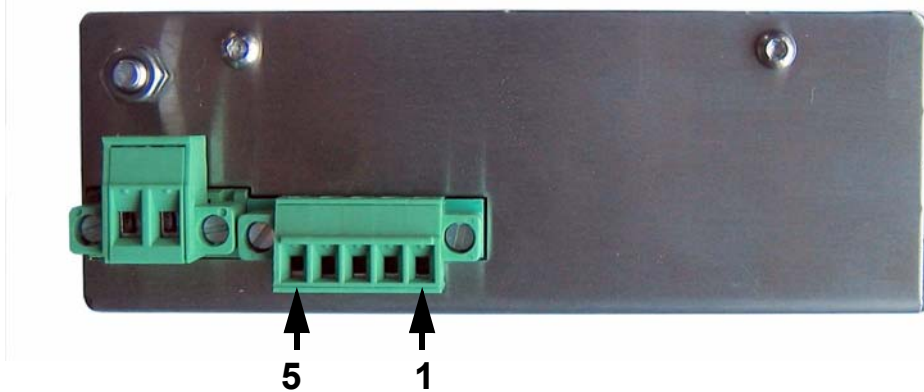

Mating female connector (included):

<b>Manufacturer:</b>	Sauro	<a href="http://www.sauro.net/">http://www.sauro.net/</a>
<b>Part Number:</b>	CTF050VT	

Pin	REF	Description
1	DO_GND	Output digital signal (0V ground) connected to the emitter of the transistor
2	DO	Output digital signal connected to the drain of the MOSFET transistor
3	DO_VDC	Common of the external predrive power supply (between +12 et +24 VDC)
4	DI_GND	Ground of the input (isolated)
5	DI	Input digital signal

Figure 11: Pinout I/O connector

## 8.5 Serial Port

Mating female connector (not included):



<b>Type</b>	Female DB9 with 4/40 blocking screws
-------------	--------------------------------------

Pinout serial port (according to mode):

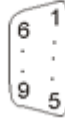

Pin	RS232	RS485	RS422
1	-	-	-
2	RXD	-	RX+
3	TXD	A+	TX+
4	-	-	-
5	GND	GND	GND
6	-	-	-
7	RTS	-	RX-
8	CTS	B-	TX-
9	-	-	-

Table 18: Pinout serial port

## 8.6 MPI port

Mating male connector (not included):

<b>Type</b>	Male DB9 with 4/40 blocking screws
-------------	------------------------------------

**MPI port pinout (DB9 female):**

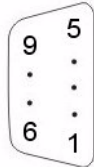

Pin	MPI
1	-
2	-
3	B(+)
4	-
5	GND
6	-
7	-
8	A(-)
9	-

Table 19: MPI port





## 8.7 PSTN / ISDN phone line connector

Mating male connector (not included):

<b>Type:</b>	RJ11 type "6P2C" without shield
--------------	---------------------------------

### • Pinout PSTN line:

Pin	Description
1	-
2	-
3	TIP
4	RING
5	-
6	-

Table 20: pinout PSTN modem

### • ISDN phone line mating male connector pinout (RJ11):

Pin	Description
1	-
2	TX+
3	RX+
4	RX-
5	TX-
6	-

Table 21: ISDN connector pinout



## 8.8 Antenna

### 8.8.1 Connector specifications

For eWON with GSM/GPRS/EDGE/HSUPA modem, the antenna connector is placed on the top of eWON.

Specification	Value
Type	SMA-F
Tightening Torque	<b>MAX 0.5N.m</b> <i>(manual tightening should be used as a reference)</i>

Table 22: Antenna connector specifications



## 8.8.2 Antenna specifications

For eWON with GSM/GPRS/EDGE/HSUPA modem, the antenna specification is as follows:

Specification	Value
Type	Quadband 850/900/1800/1900 MHz
Impedance	50 Ohms
Gain	<u>Antenna used must not exceed a gain of:</u> GPRS                    1.4 dBi @ 850 MHz 3.0 dBi @ 1900 MHz UMTS                    3.0 dBi @ all frequencies HSUPA                   2.0 dBi @ all frequencies

Table 23: Antenna specifications